

## FEATURES

- Fast Switching Speed.
- Surface Mount Package Ideally Suited For Automatic Insertion.
- For General Purpose Switching Applications
- High Conductance

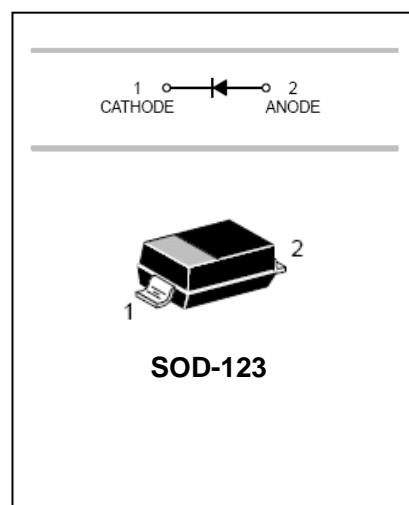

Lead-free



## APPLICATIONS

- Surface mount fast switching diode

## ORDERING INFORMATION

Type No.	Marking	Package Code
1N4448W	T5	SOD-123

## MAXIMUM RATING @ Ta=25°C unless otherwise specified

Characteristic	Symbol	Value	Unit
Non-Repetitive Peak Reverse Voltage	$V_{RM}$	100	V
Peak Repetitive Reverse Voltage	$V_{RRM}$	75	V
Working Peak Reverse Voltage	$V_{RWM}$		
DC Reverse Voltage	$V_R$		
RMS Reverse Voltage	$V_{R(RMS)}$	53	V
Average Rectified Output Current	$I_o$	250	mA
Non-Repetitive Peak Forward Surge Current @t=1.0 $\mu$ s	$I_{FSM}$	4.0	A
@t=1.0 s		2.0	
Power Dissipation	$P_d$	400	mW
Thermal Resistance Junction to Ambient Air	$R_{\theta JA}$	315	$^{\circ}C/W$
Operating and Storage Temperature Range	$T_j, T_{STG}$	-65 to +150	$^{\circ}C$

**ELECTRICAL CHARACTERISTICS @ Ta=25°C unless otherwise specified**

Characteristic	Symbol	Min	Max	Unit	Test Condition
Reverse Breakdown Voltage	$V_{(BR)R}$	75	-	V	$I_R=10\mu A$
Forward Voltage	$V_{F1}$	0.62	0.72	V	$I_F=5mA$
	$V_{F2}$	-	0.855		$I_F=10mA$
	$V_{F3}$	-	1.0		$I_F=100mA$
	$V_{F4}$	-	1.25		$I_F=150mA$
Reverse Current	$I_{RM}$	-	2.5	$\mu A$	$V_R=75V$
			25	$\mu A$	$V_R=75V, T_j=150^\circ C$
			30	$\mu A$	$V_R=25V, T_j=150^\circ C$
			25	nA	$V_R=20V$
Capacitance between terminals	$C_T$	-	4.0	pF	$V_R=0, f=1.0MHz$
Reverse Recovery Time	$t_{rr}$	-	4.0	ns	$I_F=I_R=10mA,$ $I_{tr}=0.1 \times I_R, R_L=100\Omega$

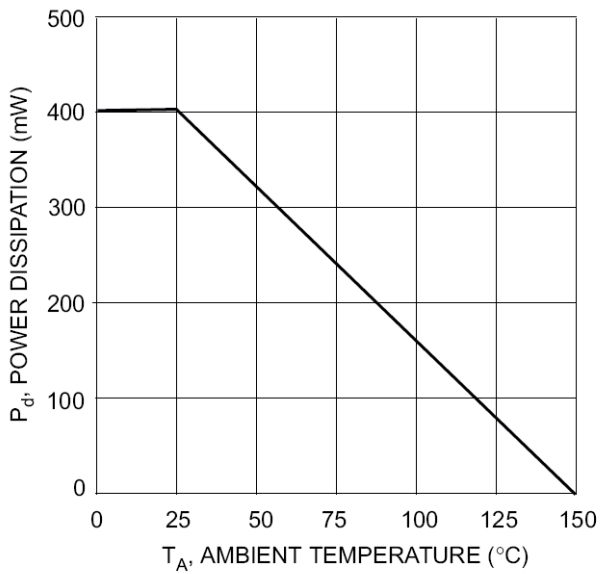

Fig. 1 Power Derating Curve

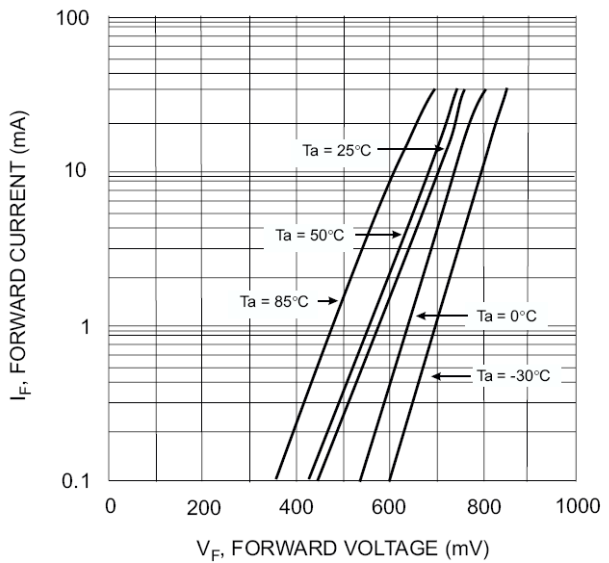

Fig. 2 Typical Forward Characteristics

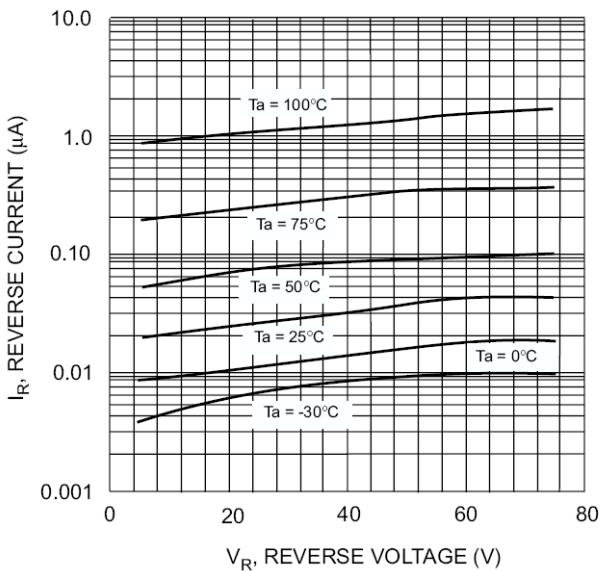

Fig. 3 Typical Reverse Characteristics

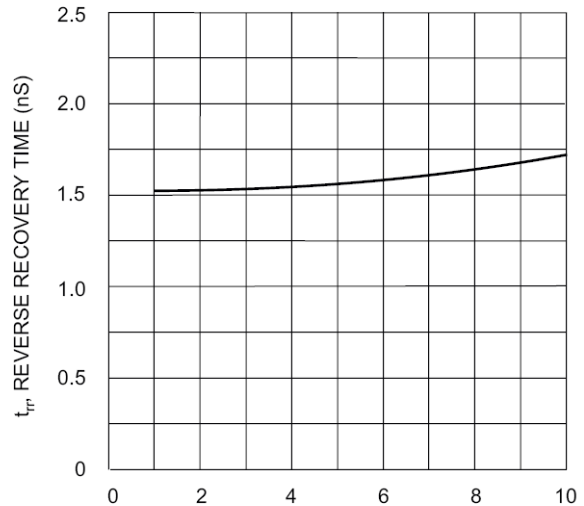

Fig. 4 Reverse Recovery Time vs. Forward Current

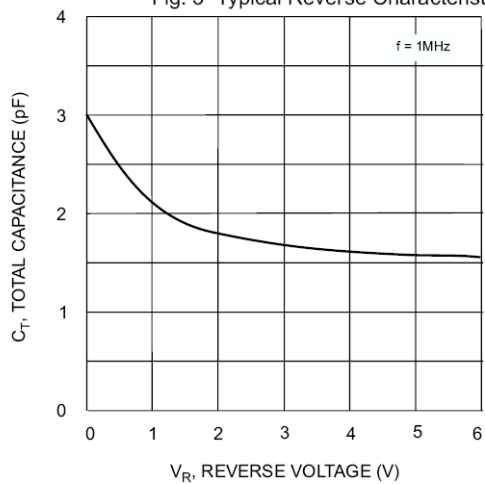
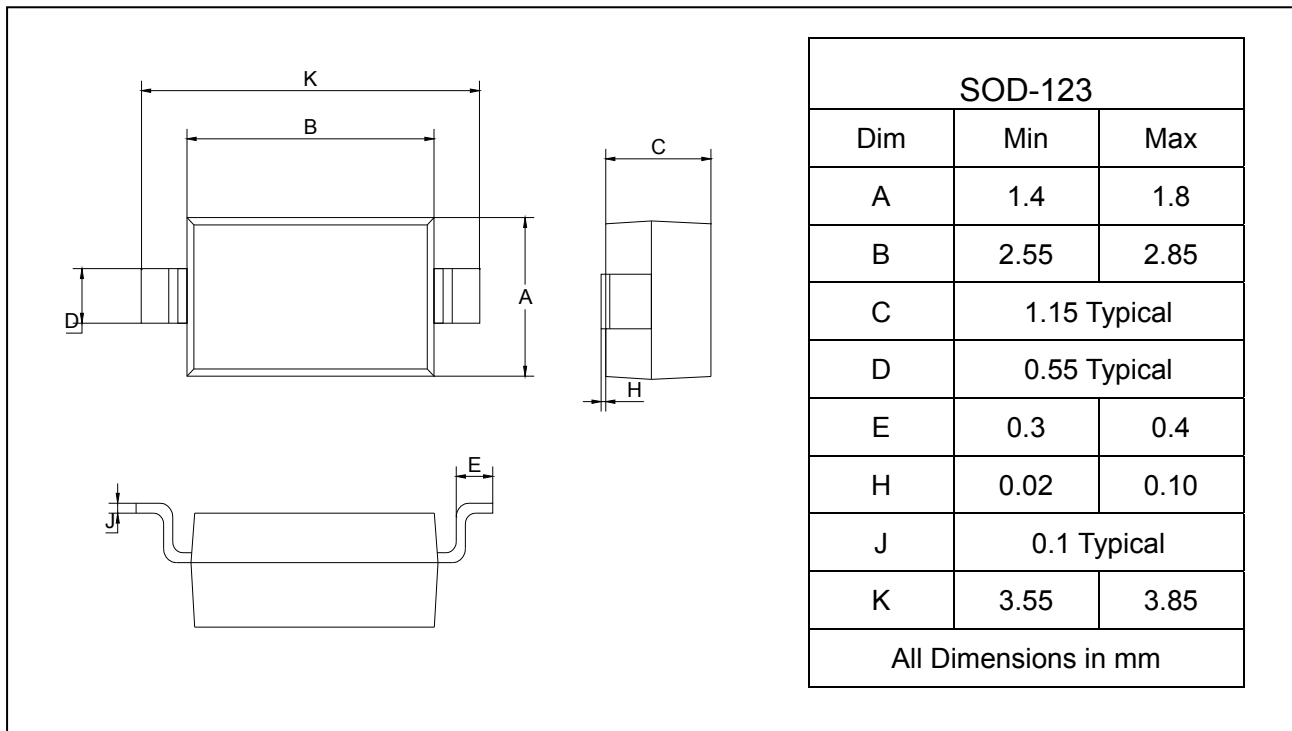

Fig. 5 Total Capacitance vs. Reverse Voltage

## PACKAGE OUTLINE

Plastic surface mounted package

SOD-123



## SOLDERING FOOTPRINT

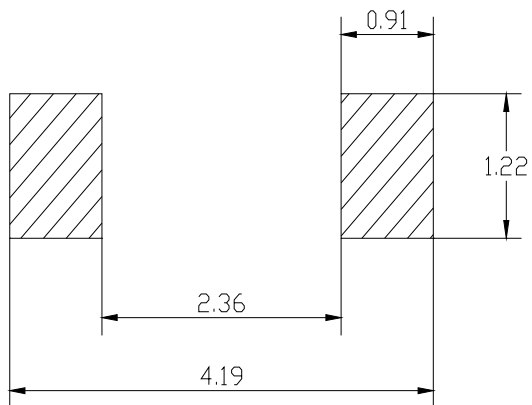

Unit: mm

## PACKAGE INFORMATION

Device	Package	Shipping
1N4448W	SOD-123	3000/Tape&Reel